

START

1

Resistor - Weerstand - Résistance - Widerstand - Resistencia - Motstand - Vastus - Resistenze

◇ R1 ... R6 : 47K

(Yellow, Purple, Orange) -(Geel, Paars, Oranje) -(Jaune, Violet, Orange) -(Gelb, Violet, Orange) -(Gul, Lila, Orange) -(Keltainen, Purppura, Oranssi) - (Amarillo, Morado, Naranja) -(Amarelo, Violeta, Laranja) - (Giallo, Viola, Aranciato)

◇ R7, R8 : 1K

(Brown, Black, Red) -(Bruin, Zwart, Rood) -(Brun, Noir, Rouge) -(Braun, Schwarz, Rot) -(Brun, Svart, Röd) -(Ruskea, Musta, Punainen) -(Marrón, Negro, Rojo) -

◇ R9 : 4K7

(Yellow, Purple, Red) -(Geel, Paars, Rood) -(Jaune, Violet, Rouge) -(Gelb, Violet, Rot) -(Gul, Lila, Röd) -(Keltainen, Purppura, Punainen) - (Amarillo, Morado, Rojo) - (Amarelo, Violeta, Encarnado) - (Giallo, Viola, Rosso)

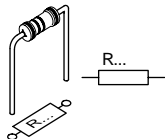

2 DIODES

Watch the polarity!
Attention à la polarité!

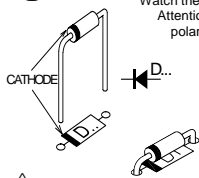

◇ D1 : 1N4007
◇ D2 : 1N4148

3 ZENERDIODES

Watch the polarity!
Attention à la polarité!

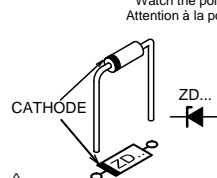

◇ ZD1 : 5V1
◇ ZD2 : 3V0

4 CAPACITOR

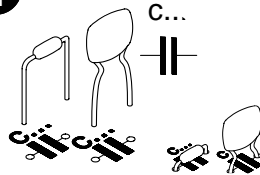

◇ C2, C3 : 100nF (104)

5 IC SOCKETS

WATCH THE POSITION
OF THE NOTCH!
ATTENTION A LA POSITION
DE L'ENCOCHE!

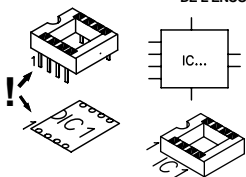

◇ IC1 : 8p
◇ IC2 : 8p

6 DIP SWITCH

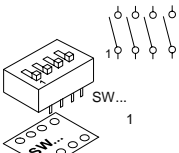

◇ SW1 : 4p

7 LEDs

Watch the polarity!
Attention à la polarité!

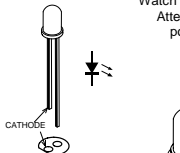

◇ LED1 : Red / Rood / Rouge / Rot / Röd / Punainen / Rojo / Encarnado / Rosso

8 TRANSISTORS

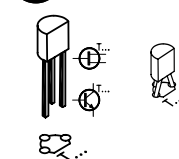

◇ T1 : BC547B

9 TRIMMER

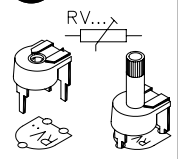

◇ RV1 : 100K

10 PCB PINS

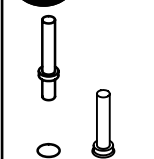

◇ SK2 (+) & (-)

11 POWER JACK

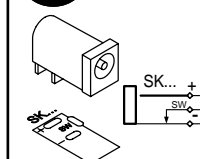

◇ SK1

12 TERMINAL BLOCK

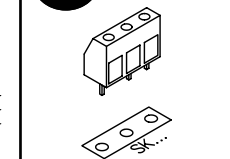

◇ SK3

13 ELECTROLYTIC CAPACITOR

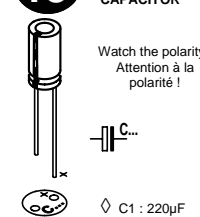

Watch the polarity!
Attention à la polarité!

◇ C1 : 220µF

14 LDR

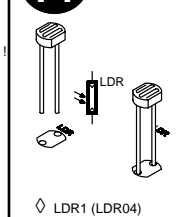

◇ LDR1 (LDR04)

15 RELAY

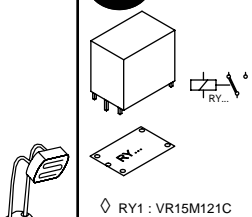

◇ RY1 : VR15M121C

16 IC'S

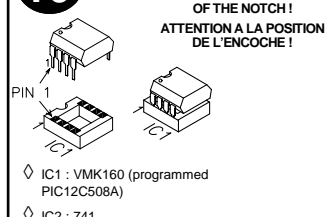

WATCH THE POSITION
OF THE NOTCH!
ATTENTION A LA POSITION
DE L'ENCOCHE!

◇ IC1 : VMK160 (programmed
PIC12C508A)
◇ IC2 : 741

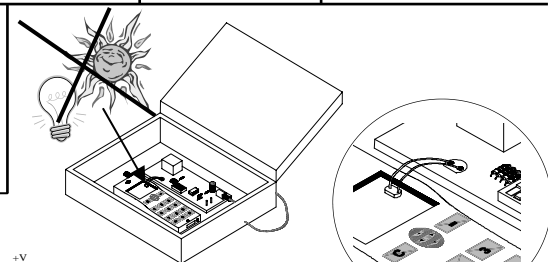
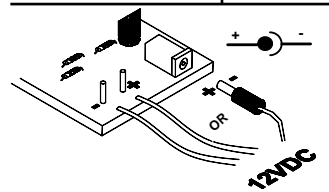

SCHEMATIC DIAGRAM

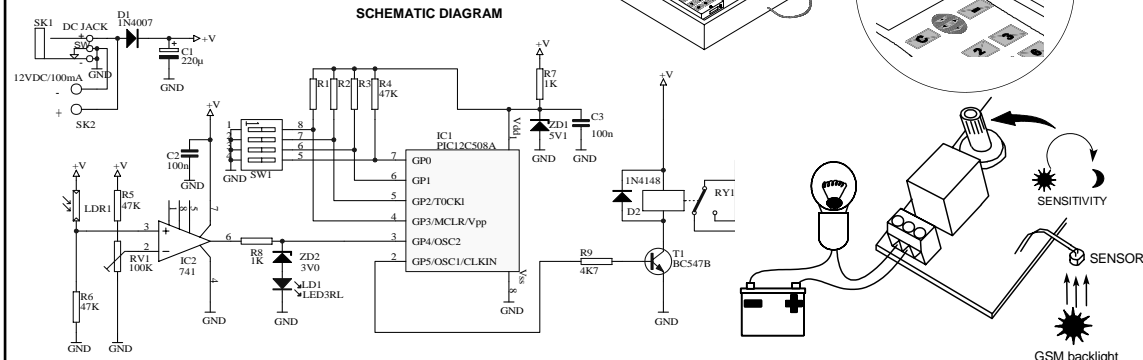

GSM backlight