

**1**

**Resistor - Weerstand - Résistance - Widerstand - Resistencia - Motstand - Vastus - Resistenze**

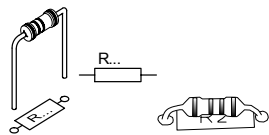

R1, R2: 100K

R3: 1M

R4: 10K

R5, R6: 1K

R7: 220K

(Brown, Black, Yellow) -(Bruin, zwart, Geel) -(Brun, Noir, Jaune) -(Braun, Schwarz, Gelb) -(Brun, Svart, Gul) -(Ruskea, Musta, Keltainen) -(Marrón, Negro, Amarillo) -(Castanho, Preto, Amarelo) -(Marrone, Nero, Giallo)

(Brown, Black, Green) -(Bruin, Zwart, Groen) -(Brun, Noir, Vert) -(Braun, Schwarz, Grün) -(Brun, Svart, Grön) -(Ruskea, Musta, Vihreä) -(Marrón, Negro, Verde) -(Castanho, Preto, Verde) -(Marrone, Nero, Verde)

(Brown, Black, Orange) -(Bruin, Zwart, Oranje) -(Brun, Noir, Orange) -(Braun, Schwarz, Orange) -(Brun, Svart, Orange) -(Ruskea, Musta, Oranssi) -(Marrón, Negro, Naranja) -(Castanho, Preto, Laranja) -(Marrone, Nero, Aranciato)

(Brown, Black, Red) -(Bruin, Zwart, Rood) -(Brun, Noir, Rouge) -(Braun, Schwarz, Rot) -(Brun, Svart, Röd) -(Ruskea, Musta, Punainen) -(Marrón, Negro, Rojo) -(Castanho, Preto, Encarnado) -(Marrone, Nero, Rosso)

(Red, Red, Yellow) -(Rood, Rood, Geel) -(Rouge, Rouge, Jaune) -(Rot, Rot, Gelb) -(Röd, Röd, Gul) -(Punainen, Punainen, Keltainen) -(Rojo, Rojo, Amarillo) -(Encarnado, Encarnado, Amarelo) -(Rosso, Rosso, Giallo)

**2**

**DIODE**

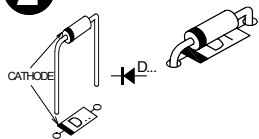

◇ D1: 1N4007  
Watch the polarity!  
Att. à la polarité!

**3**

**IC SOCKET**

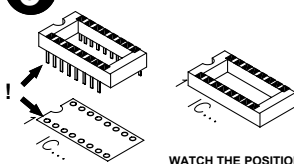

◇ IC1: 16P

WATCH THE POSITION OF THE NOTCH!  
ATTENTION A LA POSITION DE L'ENCOCHE!

**4**

**PUSHBUTTON**

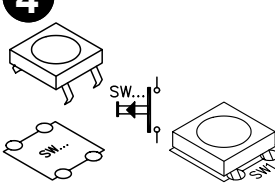

◇ SW1

**5**

**LEDs**

Watch the polarity!  
Attention à la polarité!

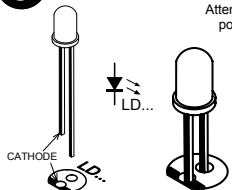

LD1: red / rood / rouge / rot / röd / punainen / rojo / encarnado / rosso  
LD2: green / groen / vert / grün / grön / vihreä / verde

**6**

**TRANSISTORS**

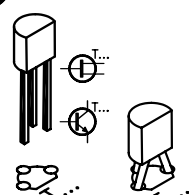

◇ T1: BC557

◇ T2: BC547

**7**

**ELECTROLYTIC CAPACITORS**

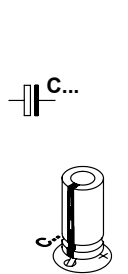

Watch the polarity!

Attention à la polarité!

◇ C1: 22µF

◇ C2: 22µF

◇ C3: 1µF

**8**

**IC**

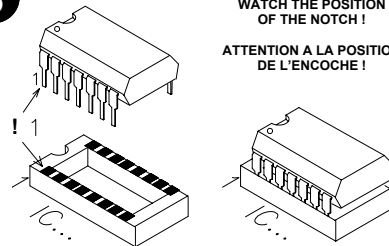

WATCH THE POSITION OF THE NOTCH!  
ATTENTION A LA POSITION DE L'ENCOCHE!

◇ IC1: CD4046 or eq.

**9**

**BATTERY HOLDER**

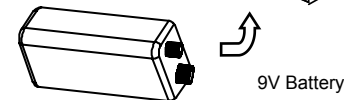
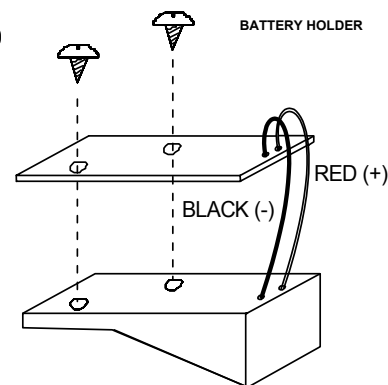

**DIAGRAM**

