

Total solder points: 101

Difficulty level:

beginner 1  2  3  4  5  advanced

velleman-kit

HIGH-Q



## Fan timer

# K8041

### Features:

- Suitable for most types of ventilators
- Solid state switching with noise suppression
- Can be connected to existing installation
- LED function indication.
- Can also be used without light as fan delay timer

### Specifications :

- Power supply: 110 to 240Vac (50/60Hz)
- Maximum load: 200W (1A)
- Delay range: from 10sec. to 5min.
- Dimensions: 80x60mm (3,2" x 2,4")

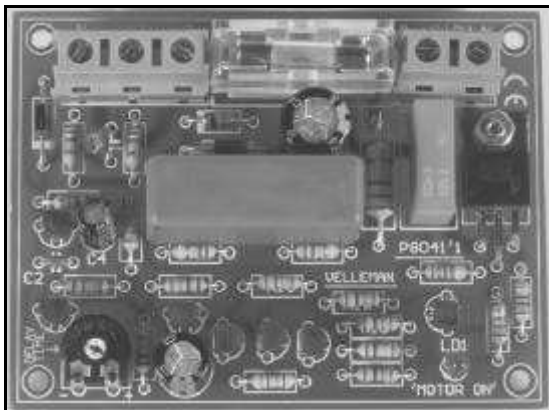



**VELLEMAN Components NV**  
**Legen Heirweg 33**  
**9890 Gavere**  
**Belgium Europe**  
**[www.velleman.be](http://www.velleman.be)**  
**[www.velleman-kit.com](http://www.velleman-kit.com)**

### 1. Assembly (Skipping this can lead to troubles !)

Ok, so we have your attention. These hints will help you to make this project successful. Read them carefully.

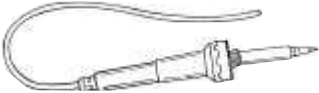
#### 1.1 Make sure you have the right tools:

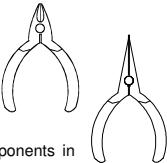
- A good quality soldering iron (25-40W) with a small tip. 
- Wipe it often on a wet sponge or cloth, to keep it clean; then apply solder to the tip, to give it a wet look. This is called 'thinning' and will protect the tip, and enables you to make good connections. When solder rolls off the tip, it needs cleaning.
- Thin raisin-core solder. Do not use any flux or grease. 
- A diagonal cutter to trim excess wires. To avoid injury when cutting excess leads, hold the lead so they cannot fly towards the eyes.
- Needle nose pliers, for bending leads, or to hold components in place. 
- Small blade and Phillips screwdrivers. A basic range is fine.



**For some projects, a basic multi-meter is required, or might be handy**

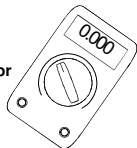

#### 1.2 Assembly Hints :

- ⇒ Make sure the skill level matches your experience, to avoid disappointments.
- ⇒ Follow the instructions carefully. Read and understand the entire step before you perform each operation.
- ⇒ Perform the assembly in the correct order as stated in this manual
- ⇒ Position all parts on the PCB (Printed Circuit Board) as shown on the drawings.
- ⇒ Values on the circuit diagram are subject to changes.
- ⇒ Values in this assembly guide are correct\*
- ⇒ Use the check-boxes to mark your progress.
- ⇒ Please read the included information on safety and customer service

\* Typographical inaccuracies excluded. Always look for possible last minute manual updates, indicated as 'NOTE' on a separate leaflet.

### 1.3 Soldering Hints :

Mount the component against the PCB surface and carefully solder the leads

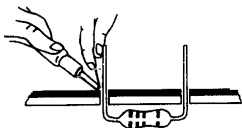

Make sure the solder joints are cone-shaped and shiny



Trim excess leads as close as possible to the solder joint

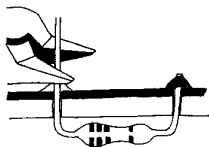

**AXIAL COMPONENTS ARE TAPED IN THE CORRECT MOUNTING SEQUENCE !**

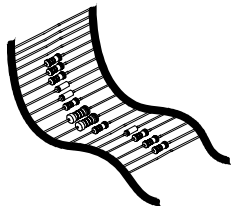

REMOVE THEM FROM THE TAPE  
ONE AT A TIME !

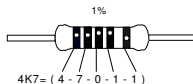
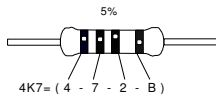

	I	P	E	SF	S	DK	N	D	GB	F	NL	
C O D E	CODICE COLORE	CODIGO DE CORES	CODIGO DE COL- ORES	VÄRI KOODI	FÄRG SCHEMA	FARVE- KODE	FARGE- KODE	FARB KODE	COLOUR CODE	CODIFI- CATION DES COU- LEURS	KLEUR KODE	C O D E
0	Nero	Preto	Negro	Musta	Svart	Sort	Sort	Schwarz	Black	Noir	Zwart	0
1	Marrone	Castanho	Marrón	Ruskea	Brun	Brun	Brun	Braun	Brown	Brun	Bruin	1
2	Rosso	Encarnado	Rojo	Punainen	Röd	Rød	Rød	Rot	Red	Rouge	Rood	2
3	Aranciato	Laranja	Naranjado	Oranssi	Orange	Orange	Orange	Orange	Orange	Orange	Oranje	3
4	Giallo	Amarelo	Amarillo	Keltainen	Gul	Gul	Gul	Gelb	Yellow	Jaune	Geel	4
5	Verde	Verde	Verde	Vihreä	Grön	Grøn	Grønn	Grün	Green	Vert	Groen	5
6	Blu	Azul	Azul	Sininen	Blå	Blå	Blå	Blau	Blue	Bleu	Blauw	6
7	Viola	Violeta	Morado	Purppura	Lila	Violet	Violet	Violet	Purple	Violet	Paars	7
8	Grigio	Cinzento	Gris	Harmaa	Grå	Grå	Grå	Grau	Grey	Gris	Grijs	8
9	Bianco	Branco	Blanco	Valkoinen	Vit	Hvid	Hvidt	Weiss	White	Blanc	Wit	9
A	Argento	Prateado	Plata	Hopea	Silver	Sølv	Sølv	Silber	Silver	Argent	Zilver	A
B	Oro	Dourado	Oro	Kulta	Guld	Guld	Guldl	Gold	Gold	Or	Goud	B

## 1. Resistors

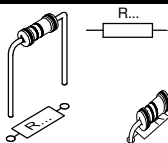

- R1 : 10K (1-0-3-B)
- R2 : 220K (2-2-4-B)
- R3 : 220K (2-2-4-B-9)
- R4 : 220K (2-2-4-B-9)
- R5 : 100K (1-0-4-B)
- R6 : 22K (2-2-3-B)
- R7 : 10K (1-0-3-B)
- R8 : 220K (2-2-4-B-9)
- R9 : 150 (1-5-1-B)
- R10: 220K (2-2-4-B)
- R11: 220K (2-2-4-B-9)
- R12: 10K (1-0-3-B)
- R13: 10K (1-0-3-B)
- R14: 100K (1-0-4-B)
- R15: 10K (1-0-3-B)
- R16: 560 (5-6-1-B)
- R17: 220 (2-2-1-B-9)
- R18: 2K2 (2-2-2-B)

## 2. 1w Resistor

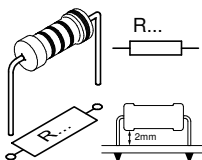

- R19: 220 (2-2-1-B)

## 3. Diodes

Watch the polarity !

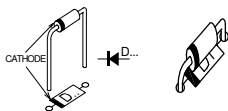

- D1: 1N4007
- D2: 1N4007

## 4. Zenerdiode

Watch the polarity !

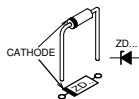

- ZD1: ZB12V0

### 5. Trim potentiometer

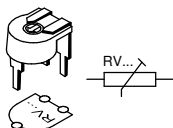

- RV1 : 10M

### 6. Triac

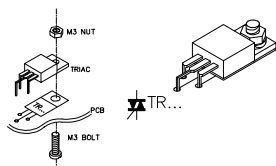

- TR1 : TIC206M

### 7. Ceramic Capacitors

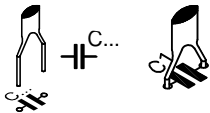

- C2: 100nF (104)
- C3: 100nF (104)

### 8. Transistors.

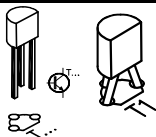

- T1: BC557B
- T2: BC547B
- T3: BC547B
- T4: BC547B
- T5: BC547B
- T6: BC547B
- T7: BC557B

### 9. LED

Watch the polarity !

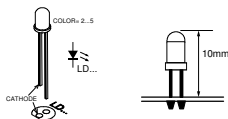

- LD1: 3mm Red (\*)

### 10. Capacitor

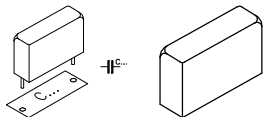

- C7 : 100nF/250V

(\*) When placing the fan timer in a housing then see pag 12 for mount- ing the LED.

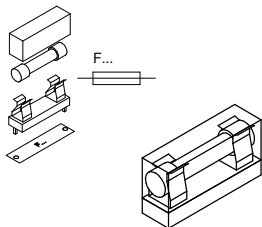
**11. Fuse holder & fuse**

- F1 : 1A (slow)

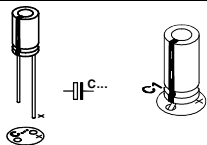
**12. Electrolytic Capacitors.  
Watch the polarity !**

- C4 : 10 $\mu$ F
- C5 : 220 $\mu$ F
- C6 : 470 $\mu$ F/25V

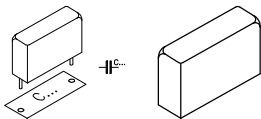
**13. Capacitor**

- C1 : 680nF/600V

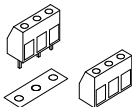
**14. Terminal Blocks**

- SK1 : 3P

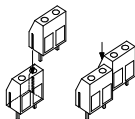

- SK2 : 2P



## 15. Connection & operation



**Note :** this kit operates on mains voltage and this may present some hazards. Disconnect the kit from the mains when working on the PCB.

### **A - Power supply :**

Connect the device to the mains (110 - 240 Vac) through connections L & N of connector SK1.

- ☞ This kit is available in various countries. Take care to use an appropriate connection.
- ☞ The connection cables should be equipped with an appropriate strain relief when mounted in a housing.

### **B - Connect the fan :**

This kit enables you to switch on a fan together with the light.

- ☞ **ATTENTION :** check the wiring carefully when connecting to an existing installation (see connection diagram p. 10).
- Connect the fan to output connector SK2.
- Connect Lx of connector SK1 to the cable linking the switch to the light source in question ( $\text{Ø}1.5\text{mm}^2$ ).
- Connect the live (L) of connector SK1 with the live of the mains.
- Connect the neutral (N) of connector SK1 to the neutral of the mains.

**Operation :** The fan starts when the lights in the room are switched on. After the lights have been extinguished, the fan will continue its operation for 5 more minutes. This delay can be adjusted by turning potentiometer RV1.

When the lights are turned on again during the deactivation delay, the fan timer will simply restart. The deactivation delay will restart after the lights are extinguished.

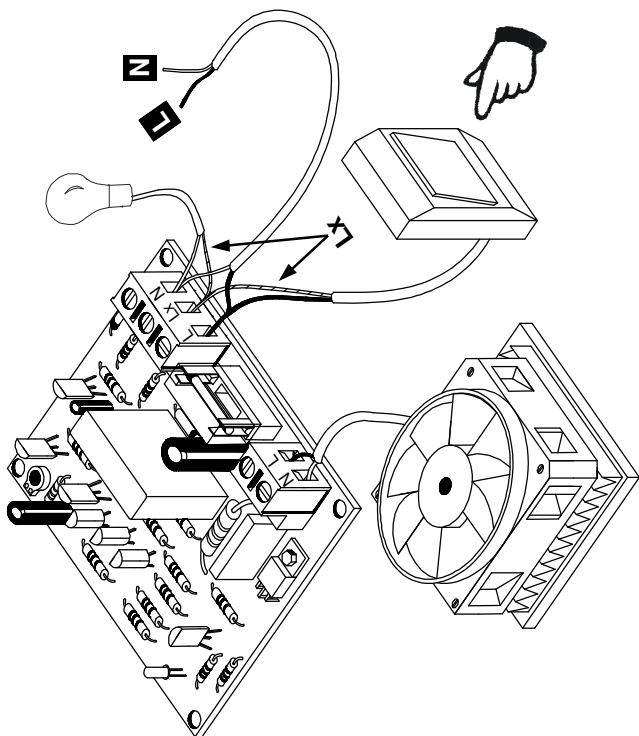
**16. Connection diagram**

**Inspect the complete assembly once more  
before applying power to the unit !**

## 17. Mounting into the optional housing

This fan timer exactly fits into the box type G311 from Velleman Components. Follow the assembly instructions below :

### 1. Drilling the holes :

- Mark the centre of the holes to be drilled on the front of the bottom enclosure. (**Fig. 1.0**)
- You can drill the left hole with a  $\varnothing$  7mm drill bit and the right hole with a  $\varnothing$  15mm bit.

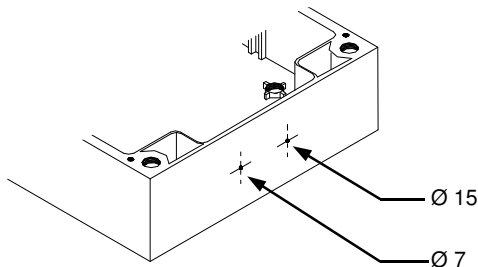

FIG. 1.0

- Mark the centre of hole to be drilled in the lid for the LED clip **Fig. 2.0**
- Drill the hole with a  $\varnothing$  4,5mm drill.

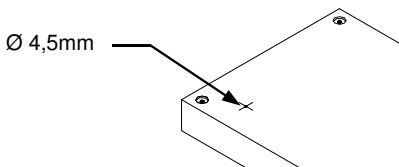

FIG. 2.0



**MAKE SURE THE EDGES OF THE HOLES ARE COMPLETELY SMOOTH.**

## 2. Mounting :

Position the PCB in the bottom half of the enclosure. (Fig. 3.0)

⚠ ATTENTION : Solder two wires onto the PCB instead of the LED. The LED will be mounted on top of the enclosure later on.

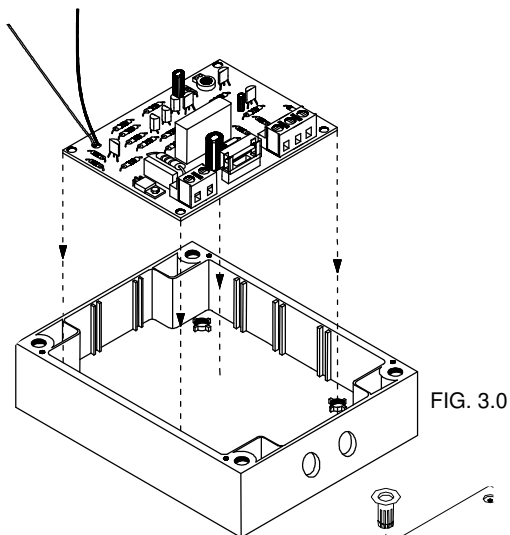

Mount the LED clip into the hole of the top enclosure, together with the LED.  
See Fig. 4.0

\* LED clip (optional)

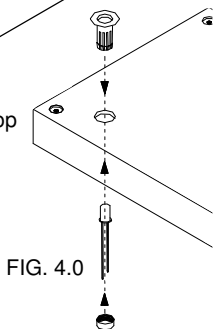

**3. Assembling :**

Pay attention when connecting the two wires with the LED.  
 Respect the polarity! Connect the fan timer as depicted in the  
 wiring diagram, see pag. 10.

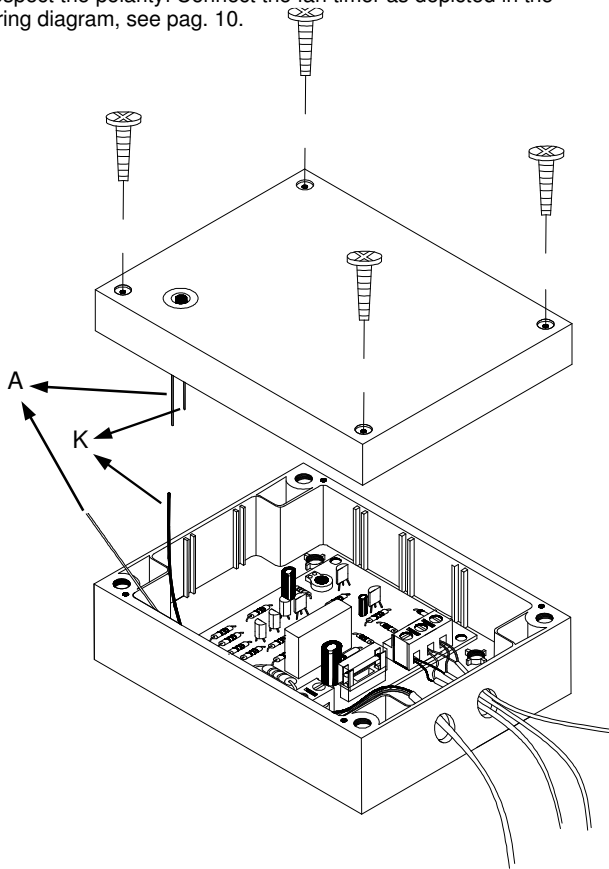

## 18. PCB layout.

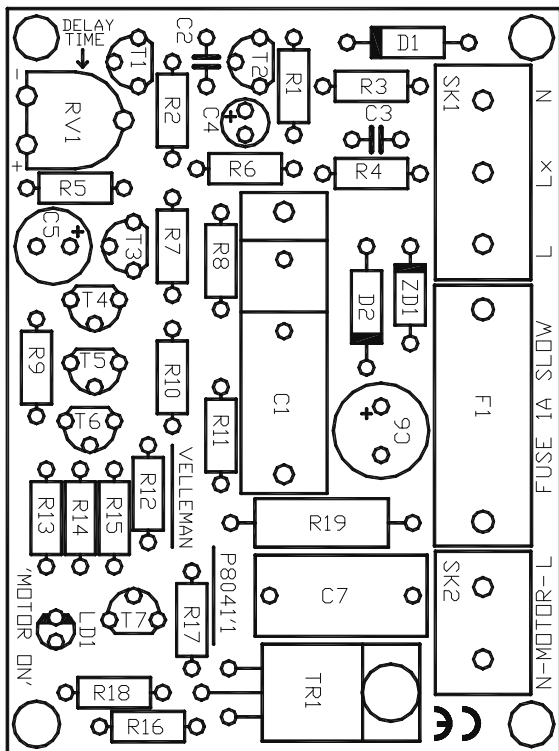

19. Schematic diagram.

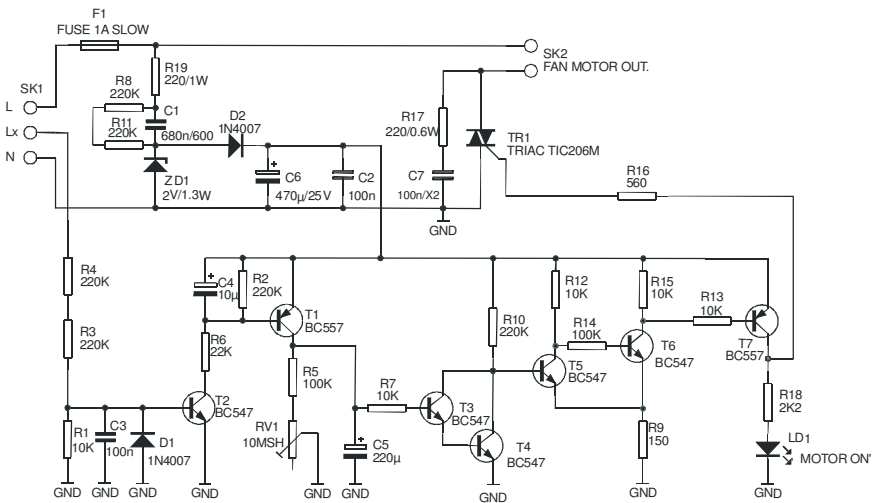

**VELLEMAN Components NV**  
**Legen Heirweg 33**  
**9890 Gavere**  
**Belgium Europe**  
**[www.velleman.be](http://www.velleman.be)**  
**[www.velleman-kit.com](http://www.velleman-kit.com)**

Modifications and typographical errors reserved  
© Velleman Components nv.  
H8041IP - 2002 - ED1