

Total solder points: 115  
Difficulty level: *beginner* 1  2  3  4  5  *advanced*

## 4 CHANNEL RUNNING LIGHT

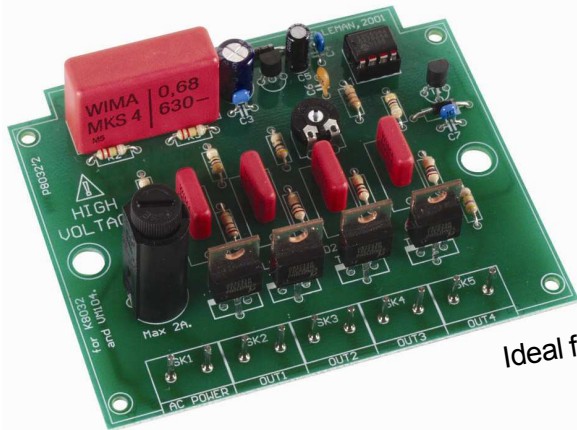

# *K8032*

*Ideal for creating disco light effects, light speed adjustable.  
Suited for inductive loads.*



**Features:**

- ☑ Adjustable speed.
- ☑ Suited for inductive loads.
- ☑ 4 channels with LED indicator.
- ☑ Ideal for disco effects.
- ☑ Noise suppressed according to EN55015.

**Specifications:**

- AC Power : 110 to 240 VAC.
- Auto frequency detection : 50/60Hz.
- Max load per channel 2A : 200W (110 - 125VAC)  
400W (220 - 240VAC)
- Adjustable speed : 0,2 to 3Hz.
- Dimensions : 100 x 82 x 35mm / 4 x 3,3 x 1,4"

### 1. Assembly (Skipping this can lead to troubles !)

Ok, so we have your attention. These hints will help you to make this project successful. Read them carefully.

#### 1.1 Make sure you have the right tools:

- A good quality soldering iron (25-40W) with a small tip.
- Wipe it often on a wet sponge or cloth, to keep it clean; then apply solder to the tip, to give it a wet look. This is called 'thinning' and will protect the tip, and enables you to make good connections. When solder rolls off the tip, it needs cleaning.
- Thin raisin-core solder. Do not use any flux or grease.
- A diagonal cutter to trim excess wires. To avoid injury when cutting excess leads, hold the lead so they cannot fly towards the eyes.
- Needle nose pliers, for bending leads, or to hold components in place.
- Small blade and Phillips screwdrivers. A basic range is fine.

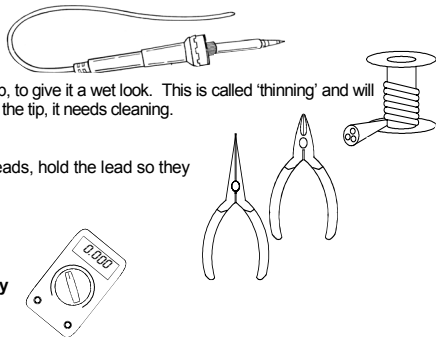

**For some projects, a basic multi-meter is required, or might be handy**

#### 1.2 Assembly Hints :

- ⇒ Make sure the skill level matches your experience, to avoid disappointments.
  - ⇒ Follow the instructions carefully. Read and understand the entire step before you perform each operation.
  - ⇒ Perform the assembly in the correct order as stated in this manual
  - ⇒ Position all parts on the PCB (Printed Circuit Board) as shown on the drawings.
  - ⇒ Values on the circuit diagram are subject to changes.
  - ⇒ Values in this assembly guide are correct\*
  - ⇒ Use the check-boxes to mark your progress.
  - ⇒ Please read the included information on safety and customer service
- \* Typographical inaccuracies excluded. Always look for possible last minute manual updates, indicated as 'NOTE' on a separate leaflet.

### 1.3 Soldering Hints :

1- Mount the component against the PCB surface and carefully solder the leads

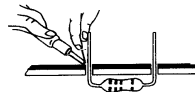

2- Make sure the solder joints are cone-shaped and shiny

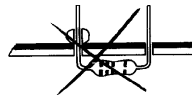
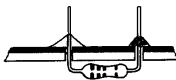

3- Trim excess leads as close as possible to the solder joint

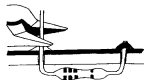

REMOVE THEM FROM THE TAPE ONE AT A TIME !

**AXIAL COMPONENTS ARE TAPED IN THE  
CORRECT MOUNTING SEQUENCE !**

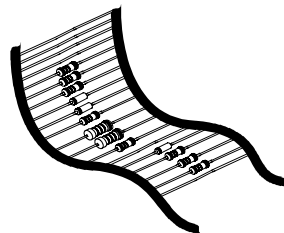

 You will find the colour code for the resistances and the LEDs in the HALG (general manual) and on our website: <http://www.velleman.be/common/service.aspx>

## 1. Zener diode. Watch the polarity !

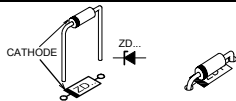

□ ZD1 : 12V0

## 2. Diodes. Watch the polarity !

□ D1 : 1N4007  
□ D2 : 1N4007

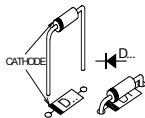

## 3. 1/4W Resistors

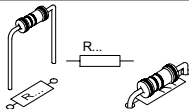

□ R4 : 3K3 (3 - 3 - 2 - B)  
□ R6 : 270 (2 - 7 - 1 - B)  
□ R7 : 270 (2 - 7 - 1 - B)

□ R8 : 270 (2 - 7 - 1 - B)  
□ R9 : 270 (2 - 7 - 1 - B)

## 4. Metal film resistors

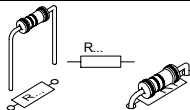

□ R2 : 220K (2 - 2 - 4 - B - 9)  
□ R3 : 220K (2 - 2 - 4 - B - 9)  
□ R5 : 470K (4 - 7 - 4 - B - 9)  
□ R10 : 47 (4 - 7 - 0 - B - 9)  
□ R11 : 47 (4 - 7 - 0 - B - 9)  
□ R12 : 47 (4 - 7 - 0 - B - 9)  
□ R13 : 47 (4 - 7 - 0 - B - 9)

## 5. IC socket. Watch the position of the notch!

□ IC1 : 8p

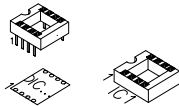

## 6. Capacitors

□ C3 : 100nF (104)  
□ C4 : 100nF (104)  
□ C6 : 100pF (101)  
□ C7 : 10nF (103)

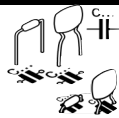

## 7. LEDs. Watch the polarity!

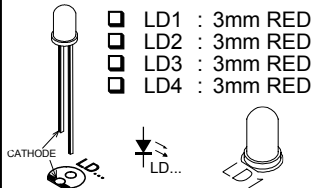

## 8. Trim potentiometer

□ RV1 : 100K

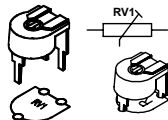

### 9. Transistor.

- T1 : BC547B

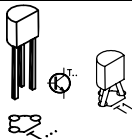

### 10. Voltage regulator

- VR1 :UA78L05

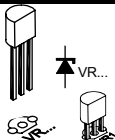

### 11. 1W Resistors

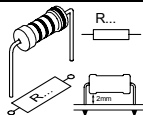

- R1 : 220 (2 - 2 - 1 - B)

### 12. Capacitors

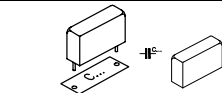

- C8 : 10nF / 600V
- C9 : 10nF / 600V
- C10 : 10nF / 600V
- C11 : 10nF / 600V

### 13. PCB tabs.

- SK1 : Power (2x)
- SK2 : OUT1 (2x)
- SK3 : OUT2 (2x)
- SK4 : OUT3 (2x)
- SK5 : OUT4 (2x)

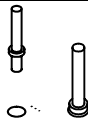

### 14. Electrolytic Capacitors. Watch the polarity !

- C2 : 220µF / 25V
- C5 : 10µF / 35V

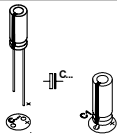

### 15. Triacs.

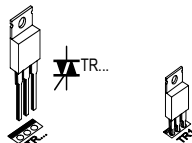

- TR1 : TIC225M
- TR2 : TIC225M
- TR3 : TIC225M
- TR4 : TIC225M

The back side corresponds to the thick line!

### 16. Fuse holder + fuse

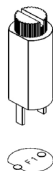

- F1 : 2A (Slow)

## 17. Capacitor

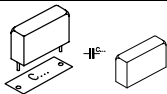

- C1 : 680nF / 600V

## 18. IC. Watch the position of the notch!

- IC1 : VK8032

Programmed PIC12C508A



**Inspect the complete assembly once more before applying power to the unit !**

## 19. Hook - up & use

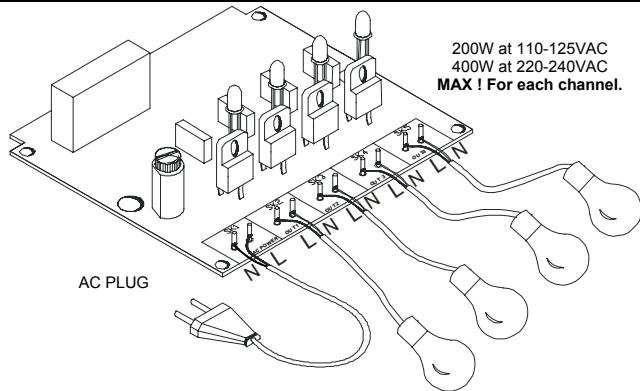

200W at 110-125VAC  
400W at 220-240VAC  
**MAX ! For each channel.**

- Solder an AC cable to the SK1 pins (AC Power).
- Solder the cables of each lampholder to the appropriate pins.

As this kit is shipped to different countries, there is no AC plug supplied. You will need to attach a plug that matches your electrical system. You can adjust the running speed by turning the trimmer "RV1". Each LED will light up when a channel is activated.



20. PCB

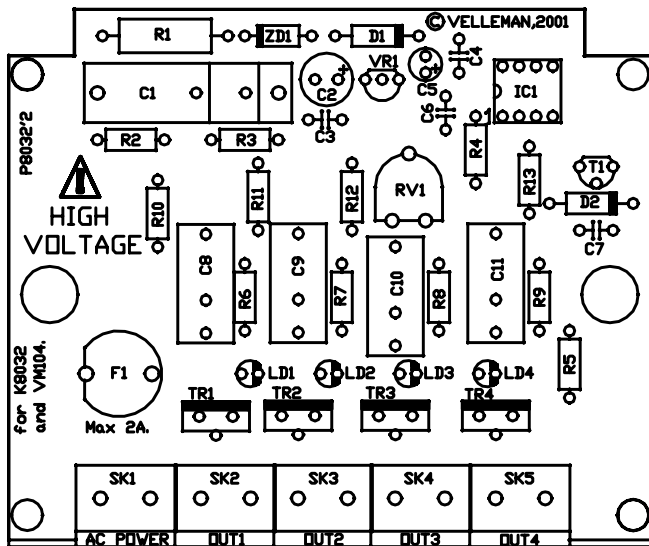

## 21. Diagram

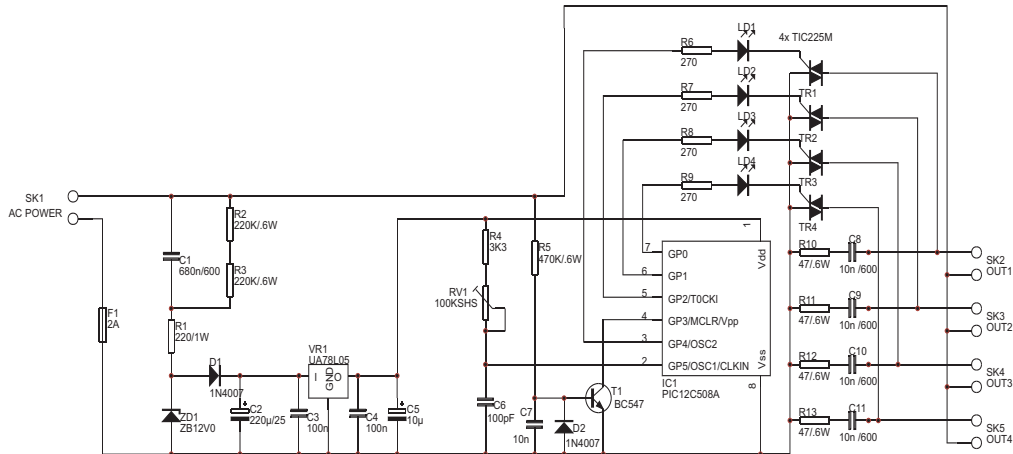





Modifications and typographical errors reserved  
© Velleman Components nv.  
H8032IP - 2004 - ED1

