

Total solder points: 96 + 43  
Difficulty level: *beginner* 1  2  3  4  5  *advanced*

# 0 TO 60 HOUR START / STOP TIMER

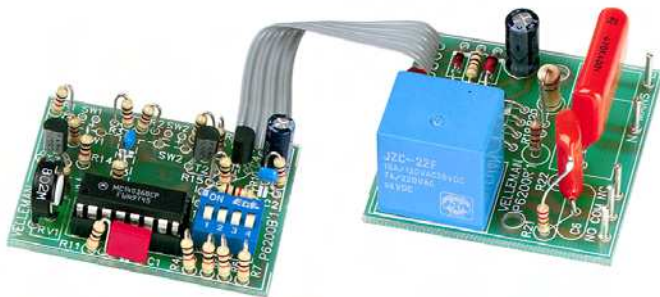

## K6200

Broad range mains operated  
start / stop timer.



If you want to have a device switched off after a given time, then this timer is the device you are looking for. Thanks to its big range this timer can be installed just about everywhere, for switching off your TV and HI-FI, the lights in the stairwell, as a security timer for your automatic coffee-maker, as a dark room timer, for making a short chime signal... etc. For the latter application you can control the start/stop timer from a switching clock such as the K6000 for example.

The rough setting (from a couple of seconds up to about 20 hours) is done using dip switches, while the fine tuning is achieved by turning a trimming potentiometer.

The timer has push buttons for starting and untimely stopping and it further allows to control the circuit by relay or open collector (e.g. our 15 channel remote controlled receiver K8050).

The circuit can be fed directly from the mains and is so compact that it fits in a standard adapter housing.

### Features:

- Relay output: 5A at 220V
- LED indication
- Setting range: from +/- 3 secs to +/- 60 hours
- Starts promptly when the start push button is pressed
- Can be operated from an external push button or relay
- Can be operated from an open collector output (\*)
- Power supply: 24VAC/50mA, 220VAC.
- Fits in an adapter housing (ex. Ordernr. B6713 or G4)

**(\*) only in case the circuit is fed from a 24V transformer.**

### 1. Assembly (Skipping this can lead to troubles !)

Ok, so we have your attention. These hints will help you to make this project successful. Read them carefully.

#### 1.1 Make sure you have the right tools:

- A good quality soldering iron (25-40W) with a small tip.
- Wipe it often on a wet sponge or cloth, to keep it clean; then apply solder to the tip, to give it a wet look. This is called 'thinning' and will protect the tip, and enables you to make good connections. When solder rolls off the tip, it needs cleaning.
- Thin raisin-core solder. Do not use any flux or grease.
- A diagonal cutter to trim excess wires. To avoid injury when cutting excess leads, hold the lead so they cannot fly towards the eyes.
- Needle nose pliers, for bending leads, or to hold components in place.
- Small blade and Phillips screwdrivers. A basic range is fine.

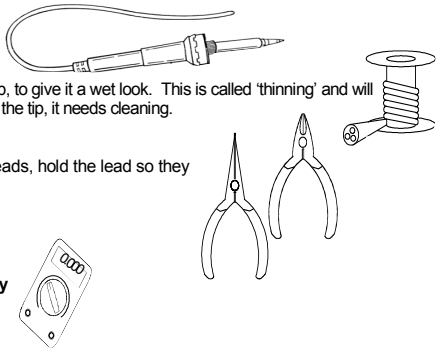

**For some projects, a basic multi-meter is required, or might be handy**

#### 1.2 Assembly Hints :

- ⇒ Make sure the skill level matches your experience, to avoid disappointments.
  - ⇒ Follow the instructions carefully. Read and understand the entire step before you perform each operation.
  - ⇒ Perform the assembly in the correct order as stated in this manual
  - ⇒ Position all parts on the PCB (Printed Circuit Board) as shown on the drawings.
  - ⇒ Values on the circuit diagram are subject to changes.
  - ⇒ Values in this assembly guide are correct\*
  - ⇒ Use the check-boxes to mark your progress.
  - ⇒ Please read the included information on safety and customer service
- \* Typographical inaccuracies excluded. Always look for possible last minute manual updates, indicated as 'NOTE' on a separate leaflet.

### 1.3 Soldering Hints :

1- Mount the component against the PCB surface and carefully solder the leads

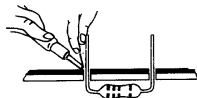

2- Make sure the solder joints are cone-shaped and shiny

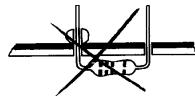
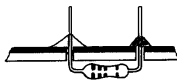

3- Trim excess leads as close as possible to the solder joint

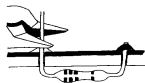

REMOVE THEM FROM THE TAPE ONE AT A TIME !

**DO NOT BLINDLY FOLLOW THE ORDER OF THE COMPONENTS ONTO THE TAPE. ALWAYS CHECK THEIR VALUE ON THE PARTS LIST!**

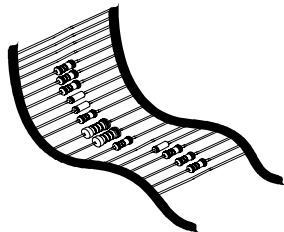

## ASSEMBLY OF THE RELAY MODULE P6200R

## 1. Diodes. Watch the polarity !

- D1 : 1N4148
- D2 : 1N4007
- D3 : 1N4007
- D4 : 1N4007
- D5 : 1N4007

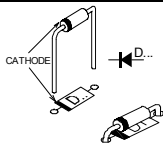

## 2. Zenerdiodes. Watch the polarity !

- ZD1 : 15V0
- ZD3 : 24V0

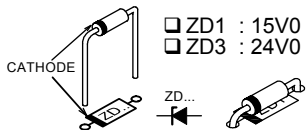

## 3. Resistor

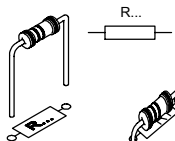

- R18: 1K (1 - 0 - 2 - B)

## 4. LED. Watch the polarity!

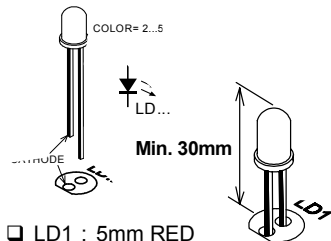

- LD1 : 5mm RED

## 5. PCB tabs

- Mains (2x)
- NO
- COM
- NC

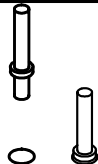

## 6. Vertical resistor

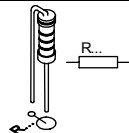

- R19 : 220 (2 - 2 - 1 - B - 9)
- R20 : 100K (1 - 0 - 4 - B)

**Pay attention :** R19 is a metal film resistor and R20 is a 1W resistor.

## 7. Choose your operating voltage

### For a 24VAC transformer :

- C7 : Jumper wire (see fig 1.0)

☞ *Required if you are going to control starting and stopping via an open collector output, e.g. the 15 channel IR receiver K8050*

### For 220 - 240VAC :

- C7 : 470nF/400V

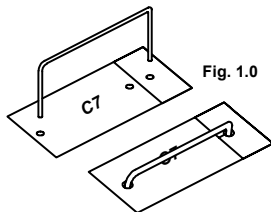
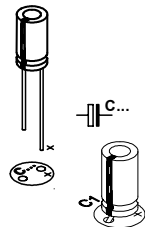

Fig. 1.0

## 8. Electrolytic Capacitor. Watch the polarity !

- C5 : 100 $\mu$ F



## 9. Relay

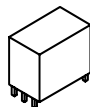

- RY1 : VR15M241C

## 10. Assembly of the suppressor network :

□ C6 : 0,1 $\mu$ F / 400V

Fit capacitor C6 vertically, with only one lead soldered.

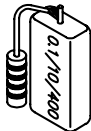

Fig. 2.0

### *In case you want to suppress the NO contact :*

Fit R21 (220 ohm 1/2W) also vertically and with only one lead soldered, where after you connect the free ends of the resistor and the capacitor together (see fig. 2.0).

### *In case you want to suppress the NC contact :*

DON'T fit R21, but R22 (220 ohm 1/2W), in the same way.

☞ **REMARK:** with small loads it may be necessary to fit a lower value for C6 (e.g. 22nF/400V), because otherwise the voltage across the load may not drop to zero when the relay is switched off.



## 11. Tips in the case of noise caused by relays:

In case the relays are used to switch alternate current, it may be necessary to suppress them.

- Suppress resistive loads (bulb, resistor, ...):

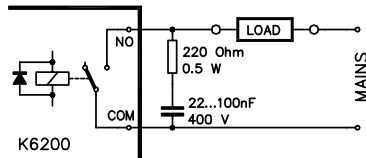

Fig. 3.1

- Suppress inductive loads (transformer, motor, ...)

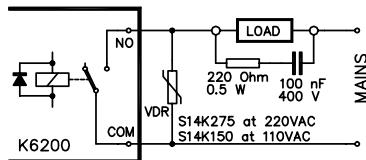

Fig. 3.2

- In case all the preceding solutions fail:

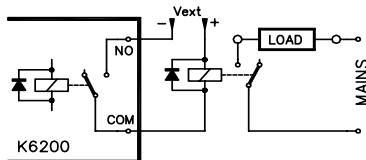

Fig. 3.3

## ASSEMBLY OF THE BASIC MODULE P6200B

## 1. Zenerdiode. Watch the polarity !



## 2. IC socket, watch the position of the notch !

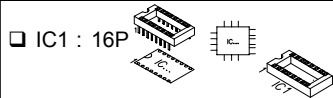

## 3. Resistor

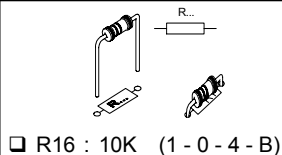

## 4. Capacitors.

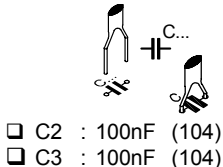

## 5. DIP switch

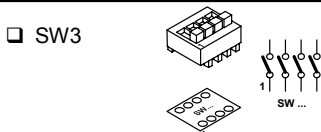

## 6. Capacitor.

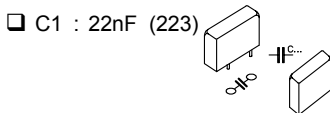

## 7. Transistors.

- T1 : BC557B  
 T2 : BC557B  
 T3 : BC557B

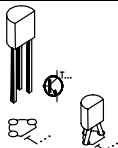

## 8. Vertical resistors

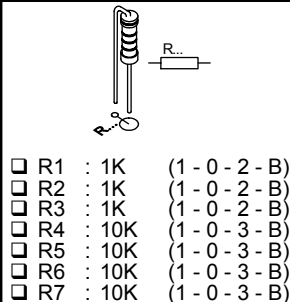

- R8 : 1K (1-0-2-B)
- R9 : 10K (1-0-3-B)
- R10 : 10K (1-0-3-B)
- R11 : 10K (1-0-3-B)
- R12 : 10K (1-0-3-B)
- R13 : 10K (1-0-3-B)
- R14 : 1K (1-0-2-B)
- R15 : 10K (1-0-3-B)
- R17 : 180K (1-8-4-B)

### 10. Trimmer

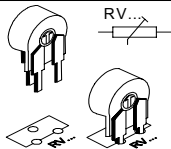

- RV1 : 220K

### 9. Electrolytic Capacitor. Watch the polarity !

- C4 : 10µF

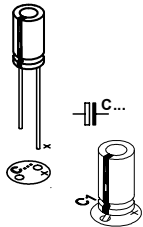

### 11. Push button

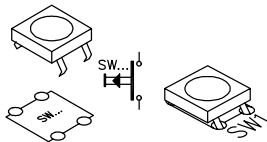

- SW1
- SW2

**Mount them on the solder side and carefully solder their connections.**

### 12. IC, Check the position of the notch!

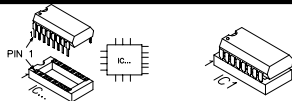

- IC1 : CD4536

### 13. Assembly of the 2 PCB's

- Connect the points RY, -, V and + of both PCB's to each other.

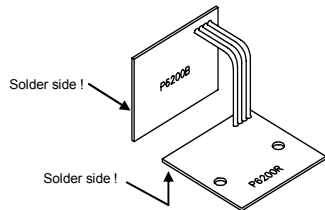

## 14. Test

- Turn RV1 to its centre position
- Check that all the switches of the DIP switch are in the OFF state
- In case the timer was built for connection to the mains, connect the mains voltage to the points marked MAINS, otherwise a transformer must be connected to these points, which can supply 24 to 28VAC at 50mA.

 **BEWARE: when using mains power, certain points in the circuit will carry this voltage.  
Be careful what you touch!**

- Press the start button. Now the relay must be activated (also the LED must come up), and released after a couple of seconds.
- Press the start button and immediately press the stop button. Now the relay must be released immediately.

## 16. Other connections

### *Connecting separate push buttons (fig. 6.0):*

- Connect two push buttons with a normal open contact to the points “+” and “-”, marked SW1 and SW2 respectively. SW2 allows to start the timer while SW1 allows to stop it.

### *Driving through open collector outputs, e.g. the 15 channel IR receiver K6711 (fig. 7.0):*

- Use a 24 to 28VAC 50mA transformer to feed the timer (attention: C7 must be short-circuited).
- Connect the “-” of one of the two push buttons to the “-” of the driving circuit.
- Connect the open collector outputs of the driving circuits to the “+” of SW1 and the “+” of SW2.

## 15. Assembly

- After the test has been performed successfully you can possibly fit the modules into an adapter housing.
- First make the holes in the cover as shown in figure 4.0

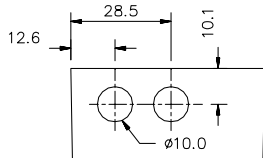
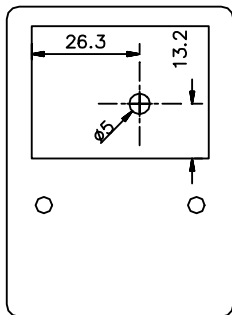

Fig. 4.0

- Connect the mains plug to the MAINS connections
- Mount the modules into the housing as shown in figure 5.0
- After having fitted the cover, check that the LED and the push buttons are in the right positions.

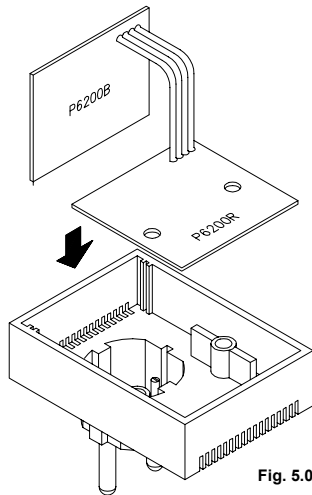

Fig. 5.0

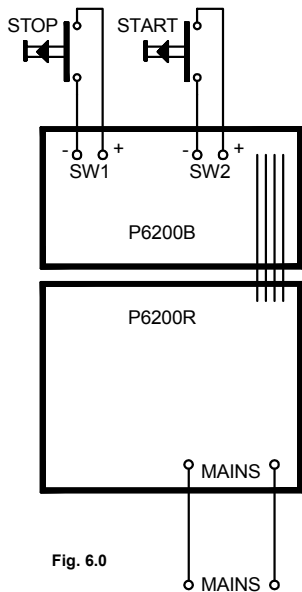

Fig. 6.0

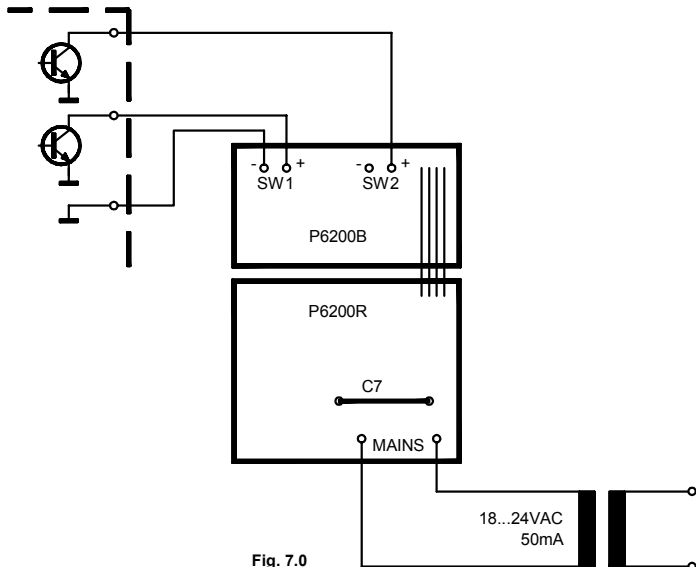

Fig. 7.0

## 17. Setting the desired time

See the table for setting the desired time.

SW3 settings				Time range
1	2	3	4	
OFF	OFF	OFF	OFF	2 - 8 sec
OFF	OFF	OFF	ON	5 - 15 sec
OFF	OFF	ON	OFF	10 - 30 sec
OFF	OFF	ON	ON	25 - 60 sec
OFF	ON	OFF	OFF	50 - 110 sec
OFF	ON	OFF	ON	1,5 - 3,5 min
OFF	ON	ON	OFF	3 - 7,5 min
OFF	ON	ON	ON	6,5 - 15 min

SW3 settings				Time range
1	2	3	4	
ON	OFF	OFF	OFF	13 - 30 min
ON	OFF	OFF	ON	25 - 60 min
ON	OFF	ON	OFF	50 - 120 min
ON	OFF	ON	ON	100 - 240 min
ON	ON	OFF	OFF	3,5 - 8 hrs
ON	ON	OFF	ON	7 - 16 hrs
ON	ON	ON	OFF	14 - 32 hrs
ON	ON	ON	ON	24 - 64 hrs

**Example:** with all switches OFF the range is 2 to 8 seconds, and the right time must be adjusted by turning trimmer RV1.

With every next setting of the switches the adjusted time is doubled. If, for example the time has been adjusted to 4 seconds, then, with the next setting (1 off, 2 off, 3 off and 4 on) the time will be set to 8 seconds. The higher you select the start time to be adjusted, the more accurate the time finally set will be.



18. PCB layout (RELAY MODULE P6200R)

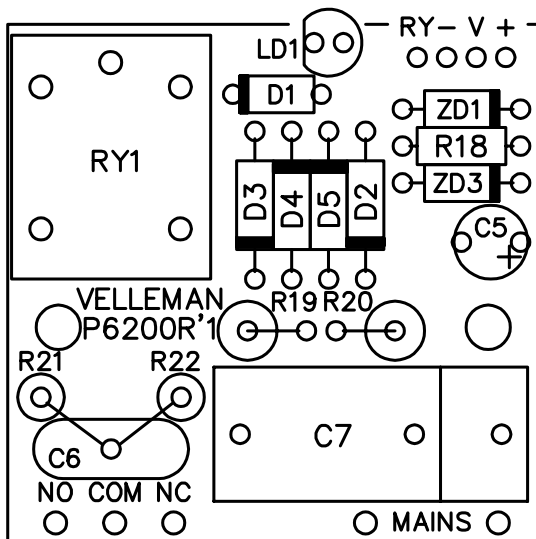

## PCB layout (BASIC MODULE P6200B)

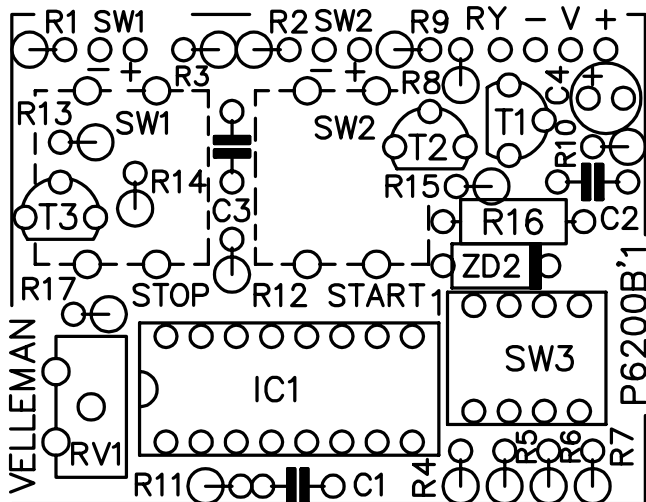

19. Diagram

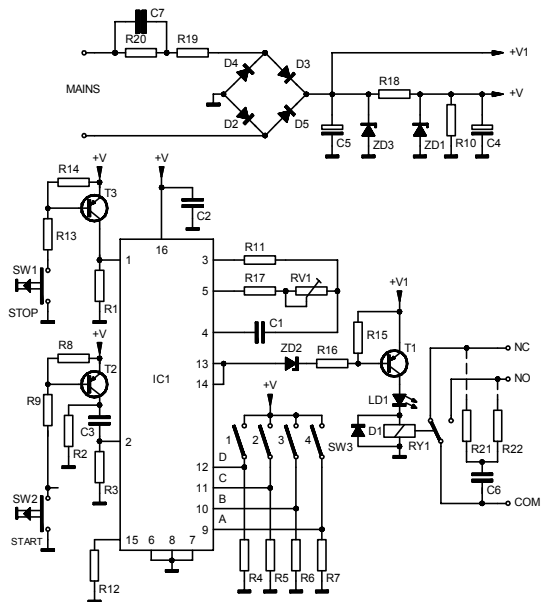

**VELBUS**  
Velleman Home Automation System

**All appliances get intelligent, how about your home?  
see our website : [www.velbus.be](http://www.velbus.be)**

Modifications and typographical errors reserved  
 © Velleman nv.  
 H6200IP - 2004 - ED1

**VELLEMAN NV**  
**Legen Heirweg 33, 9890 Gavere**  
**Belgium - Europe**

