

## 10 LED MONO VU METER

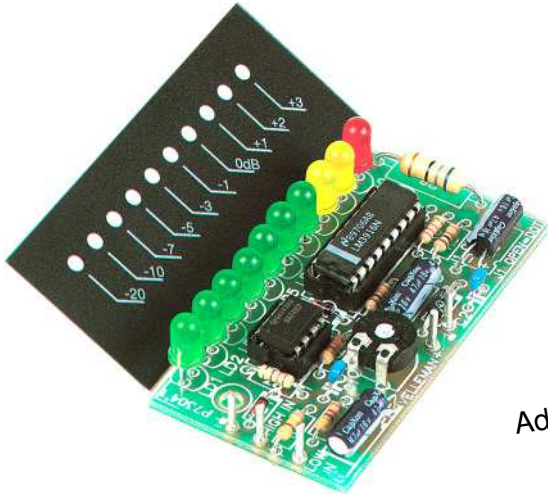

***K4304***

Add a visual readout to your existing or new equipment.

**Features:**

- ☑ For instant visualization of audio signal levels.
- ☑ Easy hook up to a LINE level ( LOW input) signal source.
- ☑ For use with mixing panels, amplifiers, CD players, radio's, ...
- ☑ A special input (HIGH INPUT) is provided, which allows direct connection to a SPEAKER output .
- ☑ DOT or BAR display mode selectable to suit your application.
- ☑ Attractive display window supplied, which can be used both horizontal as vertical.
- ☑ If wanted, the unit can be calibrated by means of a trim potentiometer.

**Specifications:**

- 1 X 10 LED's
- Bar or dot mode.
- Indication range : 0dB = 0.775mVrms.  
-20dB, -10dB, -7dB, -5dB, -3dB, -1dB, 0dB, +1dB, +2dB, +3dB
- Frequency range : 20Hz to 30KHz
- Low input for 0dB: 150mV to 6Vrms (47K)
- High input for 0dB: 1.5V to 60Vrms (470K).
- Power supply : 10 to 15VDC / 110mA max.
- PCB Dimensions : 68X37mm

 **NOT SUITED FOR CONNECTION TO HIGH POWER CAR STEREO SYSTEM**

## 1. Assembly (Skipping this can lead to troubles !)

Ok, so we have your attention. These hints will help you to make this project successful. Read them carefully.

### 1.1 Make sure you have the right tools:

- A good quality soldering iron (25-40W) with a small tip.
- Wipe it often on a wet sponge or cloth, to keep it clean; then apply solder to the tip, to give it a wet look. This is called 'thinning' and will protect the tip, and enables you to make good connections. When solder rolls off the tip, it needs cleaning.
- Thin rosin-core solder. Do not use any flux or grease.
- A diagonal cutter to trim excess wires. To avoid injury when cutting excess leads, hold the lead so they cannot fly towards the eyes.
- Needle nose pliers, for bending leads, or to hold components in place.
- Small blade and Phillips screwdrivers. A basic range is fine.

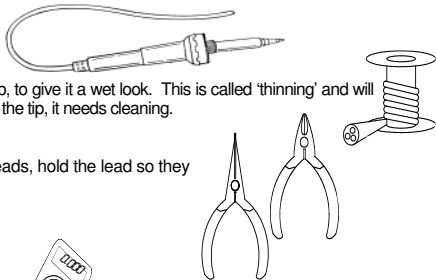

**For some projects, a basic multi-meter is required, or might be handy**



### 1.2 Assembly Hints :

- ⇒ Make sure the skill level matches your experience, to avoid disappointments.
  - ⇒ Follow the instructions carefully. Read and understand the entire step before you perform each operation.
  - ⇒ Perform the assembly in the correct order as stated in this manual
  - ⇒ Position all parts on the PCB (Printed Circuit Board) as shown on the drawings.
  - ⇒ Values on the circuit diagram are subject to changes.
  - ⇒ Values in this assembly guide are correct\*
  - ⇒ Use the check-boxes to mark your progress.
  - ⇒ Please read the included information on safety and customer service
- \* Typographical inaccuracies excluded. Always look for possible last minute manual updates, indicated as 'NOTE' on a separate leaflet.

**1.3 Soldering Hints :**

1- Mount the component against the PCB surface and carefully solder the leads

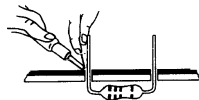

2- Make sure the solder joints are cone-shaped and shiny

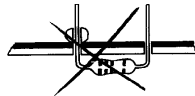
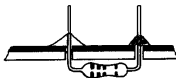

3- Trim excess leads as close as possible to the solder joint

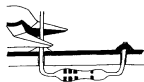

**REMOVE THEM FROM THE TAPE ONE AT A TIME !**

**AXIAL COMPONENTS ARE TAPED IN THE CORRECT MOUNTING SEQUENCE !**

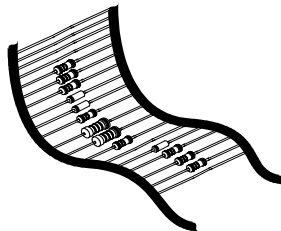

## 1. Jumper wires

J1

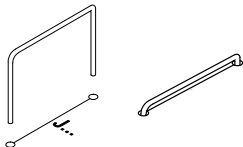

J2, mount for **BAR** mode, do not mount for **DOT** mode.

**BAR**

**DOT**

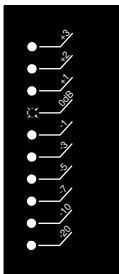
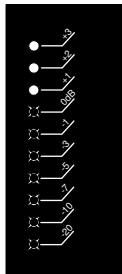

## 2. Diodes. Watch the polarity !

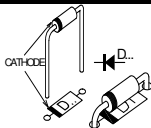

- D1 : 1N4148
- D2 : 1N4148

## 3. Zenerdiode. Watch the polarity !

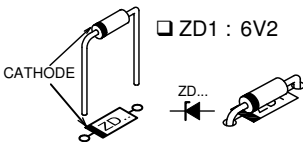

ZD1 : 6V2

## 4. Diode. Watch the polarity !



D3 : 1N4007

## 5. Resistors

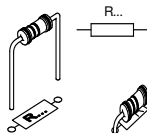

- R1 : 47K (4 - 7 - 3 - B)
- R2 : 47K (4 - 7 - 3 - B)
- R3 : 330 (3 - 3 - 1 - B)
- R4 : 10K (1 - 0 - 3 - B)
- R5 : 10K (1 - 0 - 3 - B)
- R6 : 2K2 (2 - 2 - 2 - B)
- R7 : 470K (4 - 7 - 4 - B)

## 6. IC sockets. Watch the position of the notch!

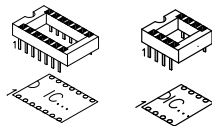

- IC1 : 8p
- IC2 : 18p

## 7. Capacitors.

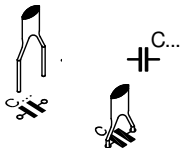

- C1 : 220nF (224)
- C2 : 220nF (224)

## 10. 1W resistor

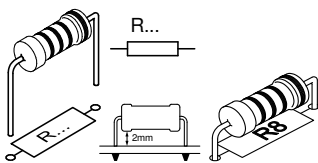

- R8 : 68 (6 - 8 - 0 - B)

## 8. Trim potentiometer

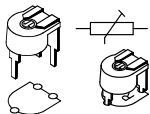

- RV1 : 220K  
(Sensitivity)

9. Electrolytic Capacitors.  
Watch the polarity !

- C3 : 47 $\mu$ F
- C4 : 47 $\mu$ F
- C5 : 47 $\mu$ F

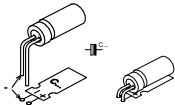

## 11. IC's. Watch the polarity !

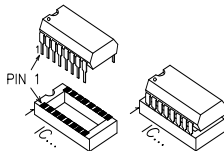

- IC1 : UA741
- IC2 : LM3916

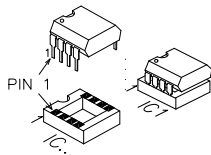

## 12. MOUNT THE LEDs (Check the polarity)

**Remark:** Depending on your application, these LED's can be mounted perpendicular or parallel (see also points 13 and 14):

- |                                      |                                      |                                      |                                       |                                       |
|--------------------------------------|--------------------------------------|--------------------------------------|---------------------------------------|---------------------------------------|
| <input type="checkbox"/> LD1 : green | <input type="checkbox"/> LD3 : green | <input type="checkbox"/> LD5 : green | <input type="checkbox"/> LD7 : green  | <input type="checkbox"/> LD9 : yellow |
| <input type="checkbox"/> LD2 : green | <input type="checkbox"/> LD4 : green | <input type="checkbox"/> LD6 : green | <input type="checkbox"/> LD8 : yellow | <input type="checkbox"/> LD10 : red   |

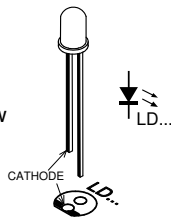

### Perpendicular mounting :

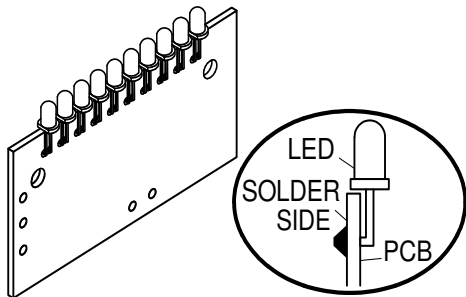

### Parallel mounting :

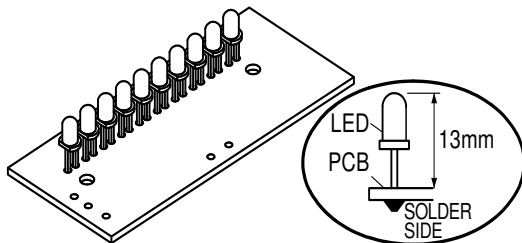

### 13. PARALLEL MOUNTING (optional)

(A) Make the holes in the housing or panel (fig.1.0) :

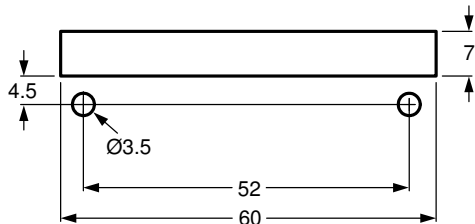

Fig. 1.0

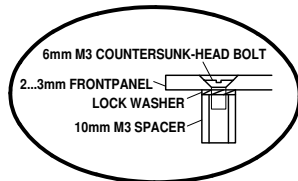
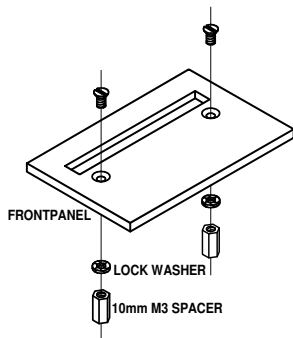
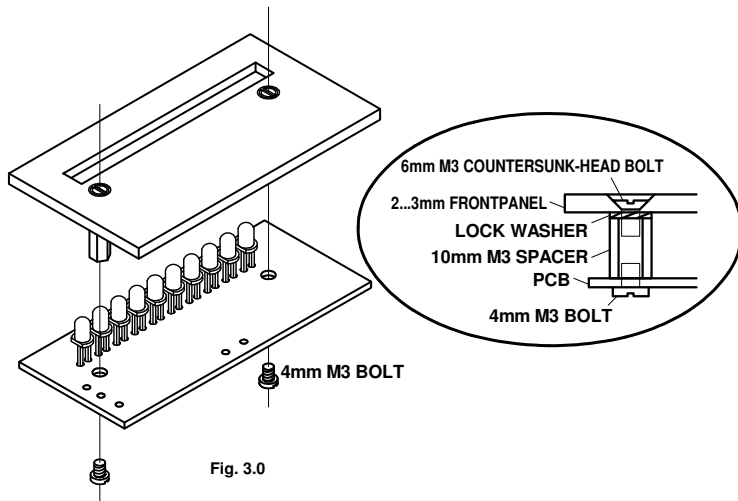

Fig. 2.0

(B) Mount the suitable spacers (fig. 2.0) :



(C) Mount the PCB onto the spacers (fig 3.0) :



## 14. PERPENDICULAR MOUNTING (optional)

(A) Make or search for a suitable bracket :

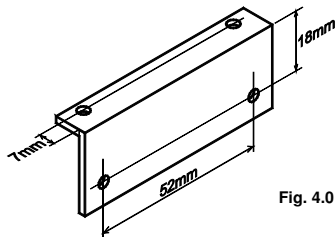
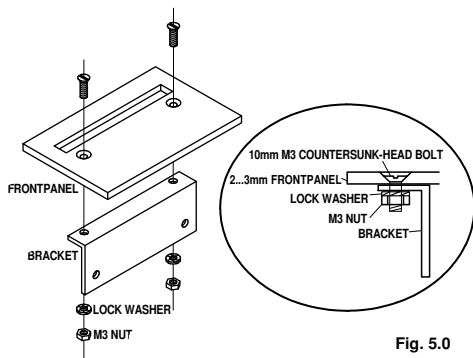

(B) Make the holes in the housing or panel and mount the bracket (fig. 5.0) :

(C) Mount the PCB with spacers onto the bracket (fig. 6.0) :

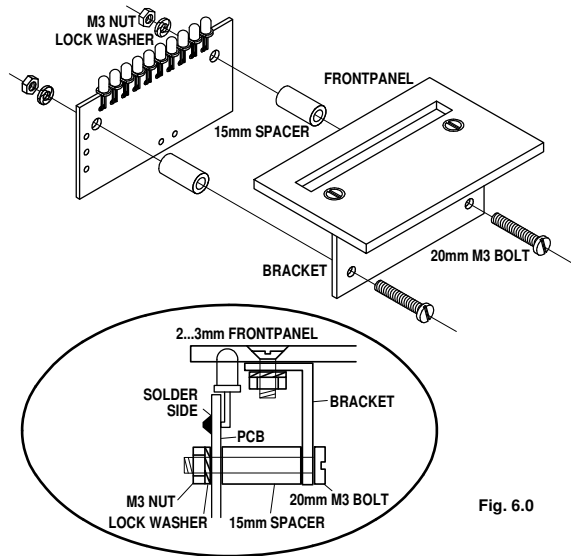

Fig. 6.0

## 15. CONNECTION TO A SUITABLE SIGNAL

Connecting to a line level output (tuner, preamp, cd player... ) and connecting a power supply from 10 to 15VDC / 110mA max..

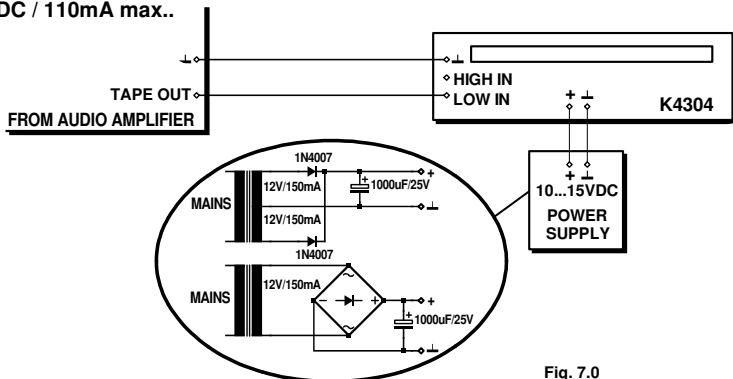

Fig. 7.0

Connect the unit to a suitable supply voltage between 10VDC and 15VDC, this can also be a standard DC adapter. You can also build your own power supply, see diagram. Use a 2x12V transformer, two rectifier diodes and a electrolytic capacitor or use a single 12V transformer with a bridge rectifier and a electrolytic capacitor.

## 16. CONNECTION TO A SPEAKER OUTPUT

Connecting to a speaker level output and connecting a power supply from 10 to 15VDC / 110mA max.

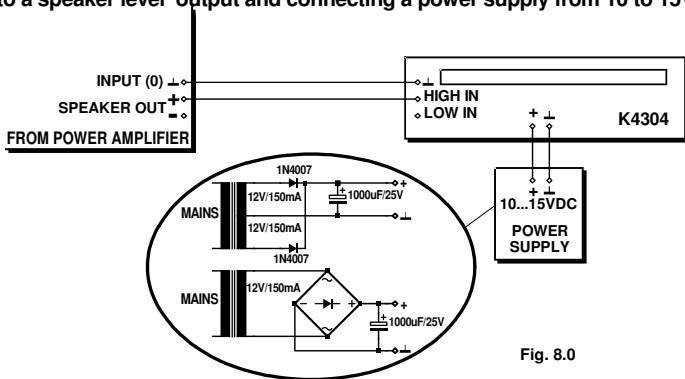

Fig. 8.0

Connect the unit to a suitable supply voltage between 10VDC and 15VDC, this can also be a standard DC adapter. You can also build your own power supply, see diagram. Use a 2x12V transformer, two rectifier diodes and a electrolytic capacitor or use a single 12V transformer with a bridge rectifier and a electrolytic capacitor.

## 17. CONNECTION TO A CAR RADIO

Connecting to a speaker output from a regular car radio.

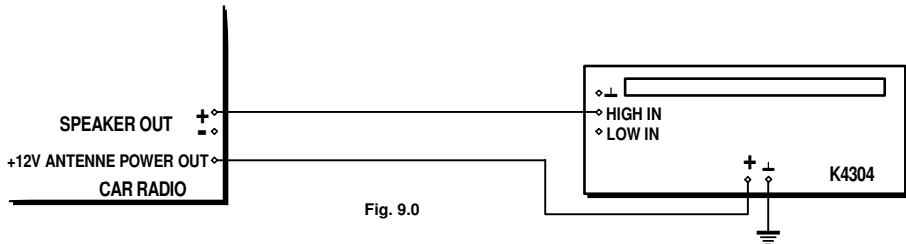

Fig. 9.0

The 12VDC car battery power or car radio antenna output can be used to supply the VU meter.

**REMARK:** Do not connect the unit to a high power car booster or car stereo, this equipment uses isolated ground connection. The connection to this kind of amplifier can cause permanent damage to the amplifier or car radio!

**Adjust the units sensitivity according to your preference by means of the trim potentiometer RV1**

## 18. PCB LAYOUT

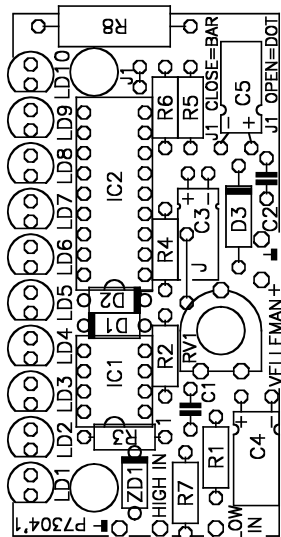

## 19. DIAGRAM

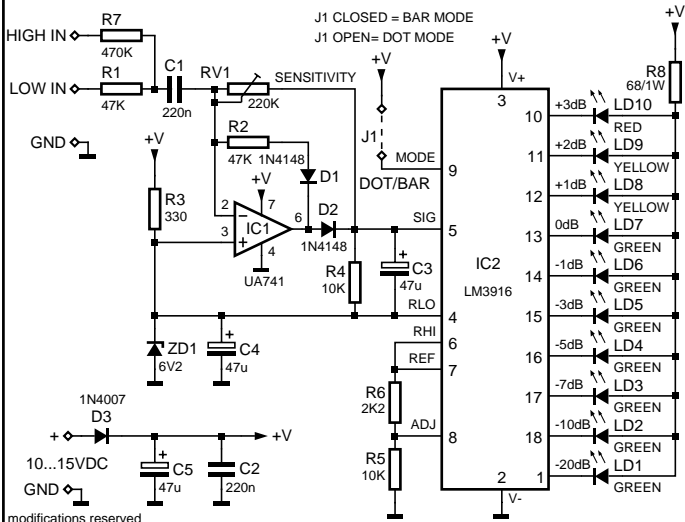



VELLEMAN NV  
Legen Heirweg 33, B-9890 GAVERE  
Belgium (Europe)

 @velleman\_RnD

